

Technical Data

2200 Series

Electropak

2206C-E13TAG2

2206C-E13TAG3

Basic technical data

Number of cylinders	6
Cylinder arrangement	vertical in-line
Cycle	4 stroke
Induction system	turbocharged, air-to-air charge cooling
Combustion system	direct injection diesel
Compression ratio	16,3:1
Bore	130 mm
Stroke	157 mm
Cubic capacity	12,5 litres
Direction of rotation	anti-clockwise when viewed from flywheel
Firing order (number 1 cylinder furthest from flywheel)	1-5-3-6-2-4
Estimated total weight of Electropak (dry)	1478 kg
Estimated total weight of Electropak (wet)	1582 kg

Overall dimensions - Electropak

-height	1725 mm
-length (air cleaner fitted)	2410 mm
-width	1120 mm

Moments of inertia (mk²)

Engine	1,36 kgm ²
Flywheel	1.41 kgm ²

Centre of gravity

Forward of rear face of cylinder block	650 mm
Above crankshaft centre line	250 mm

Cyclic irregularity

-1500 rev/min	1,54
-1800 rev/min	1,82

Performance

Note: All data based on operation to ISO 3046-1/1, BS5514 AND DIN 627 standard reference conditions.

All data based on 42584 MJ/kg calorific value for diesel conforming to specification BS2869 Class A2

All ratings certified to within $\pm 3\%$
Steady state speed capability at constant load - G2... $\pm 0,25\%$

Test conditions

-air temperature	25 °C
-barometric pressure	100 kPa
-relative humidity	30 %
-air inlet restriction at maximum power (nominal)	2,5 kPa
-exhaust back pressure at maximum power (nominal)	6,8 kPa
-fuel temperature (inlet pump)	40 °C

Sound level

Sound pressure level (exhaust piped away, cooling pack and air cleaner fitted)

-1500 rev/min	102,5 dB(A)
-1800 rev/min	104,6 dB(A)

If the engine is to operate in ambient conditions other than those of the test conditions, suitable adjustments must be made for these changes. For full details, contact Perkins Technical Service Department. **Emissions capability:** Certified against the requirements of EU2007 Stage II (EU 97/68/EC Stage II) legislation for non road mobile machinery, powered by constant speed engines. These engines also comply with the 1/2 TA Luft (1986) NOx limits of 2000 mg/nm³

General installation - 2206C-E13TAG2

Designation	Units	Prime	Standby	Prime	Standby
		50Hz @ 1500 rev/min		60Hz @ 1800 rev/min	
Gross engine power	kWb	324,2	368,4	373,4	406,5
Brake mean effective pressure	kPa	2061	2356	1984	2171
Combustion air flow (at rated speed)	m ³ /min	25,2	26,2	28,1	29,6
Exhaust gas flow (Max.)	m ³ /min	67,3	71,8	68,3	74,4
Exhaust gas mass flow	kg/min	29,5	30,9	32,6	34,4
Exhaust gas temperature (turbocharger outlet)	°C	630	630	680	680
Boost pressure ratio		3,2	3,4	3,2	3,4
Overall thermal efficiency (nett)	%	38,2	39,2	40,6	40,2
Typical genset electrical output (0.8pf 25 °C)	kWe	280	320	320	350
	kVA	350	400	400	438
Assumed alternator efficiency	%	92		92	
Energy balance					
Energy in fuel	kWt	795,8	886,3	857,1	945,4
Energy in power output (gross)	kWb	324,2	368,4	373,4	406,5
Energy to additional losses	kWb	4,9	5,5	5,6	6,1
Energy to cooling fan	kWm	14		19	
Energy in power output (nett)	kWt	305,3	348,9	348,8	381,4
Energy to exhaust	kWt	251,8	274,5	250,6	278,6
Energy to coolant and lubricating oil	kWt	118,4	131,3	127,5	138,2
Energy to charge cooler	kWt	67,4	77,2	69,1	79,2
Energy to radiation	kWt	33,9	35,0	36,5	42,9

General installation - 2206C-E13TAG3

Designation	Units	Prime	Standby	Prime	Standby
		50Hz @ 1500 rev/min		60Hz @ 1800 rev/min	
Gross engine power	kWb	368,4	412,5	373,4	406,5
Brake mean effective pressure	kPa	2345	2637	1984	2171
Combustion air flow (at rated speed)	m³/min	26,7	27,4	28,1	29,5
Exhaust gas flow (Max.)	m³/min	72	75,8	68,3	74,4
Exhaust gas mass flow	kg/min	31,2	32,2	32,6	34,4
Exhaust gas temperature (turbocharger outlet)	°C	630	630	680	680
Boost pressure ratio		3,4	3,3	3,2	3,4
Overall thermal efficiency (nett)	%	39,1	40,3	40,6	40,2
Typical genset electrical output (0.8pf 25 °C)	kWe	320	360	320	350
	kVA	400	450	400	438
Assumed alternator efficiency	%	92		92	
Energy balance					
Energy in fuel	kWt	890,3	971,9	857,1	945,4
Energy in power output (gross)	kWb	368,4	412,5	373,4	406,5
Energy to additional losses	kWb	5,5	6,2	5,6	6,1
Energy to cooling fan	kWm	14		19	
Energy in power output (nett)	kWt	348,9	392,3	348,8	381,4
Energy to exhaust	kWt	285,1	303,3	250,6	278,6
Energy to coolant and lubricating oil	kWt	127,5	139,8	127,5	138,2
Energy to charge cooler	kWt	72,5	78,8	69,1	79,2
Energy to radiation	kWt	36,8	37,6	36,5	42,9

Rating definitions

Prime power

Variable load. Unlimited hours usage with an average load factor of 70% of the published prime power rating over each 24 hour period. A 10% overload is available for 1 hour in every 12 hours of operation.

Standby power

Variable load. Limited to 500 hours annual usage up to 300 hours of which may be continuous running, No overload is permitted

2206C-E13TAG2 and 2206C-E13TAG3 - GA Z13622 (50Hz)

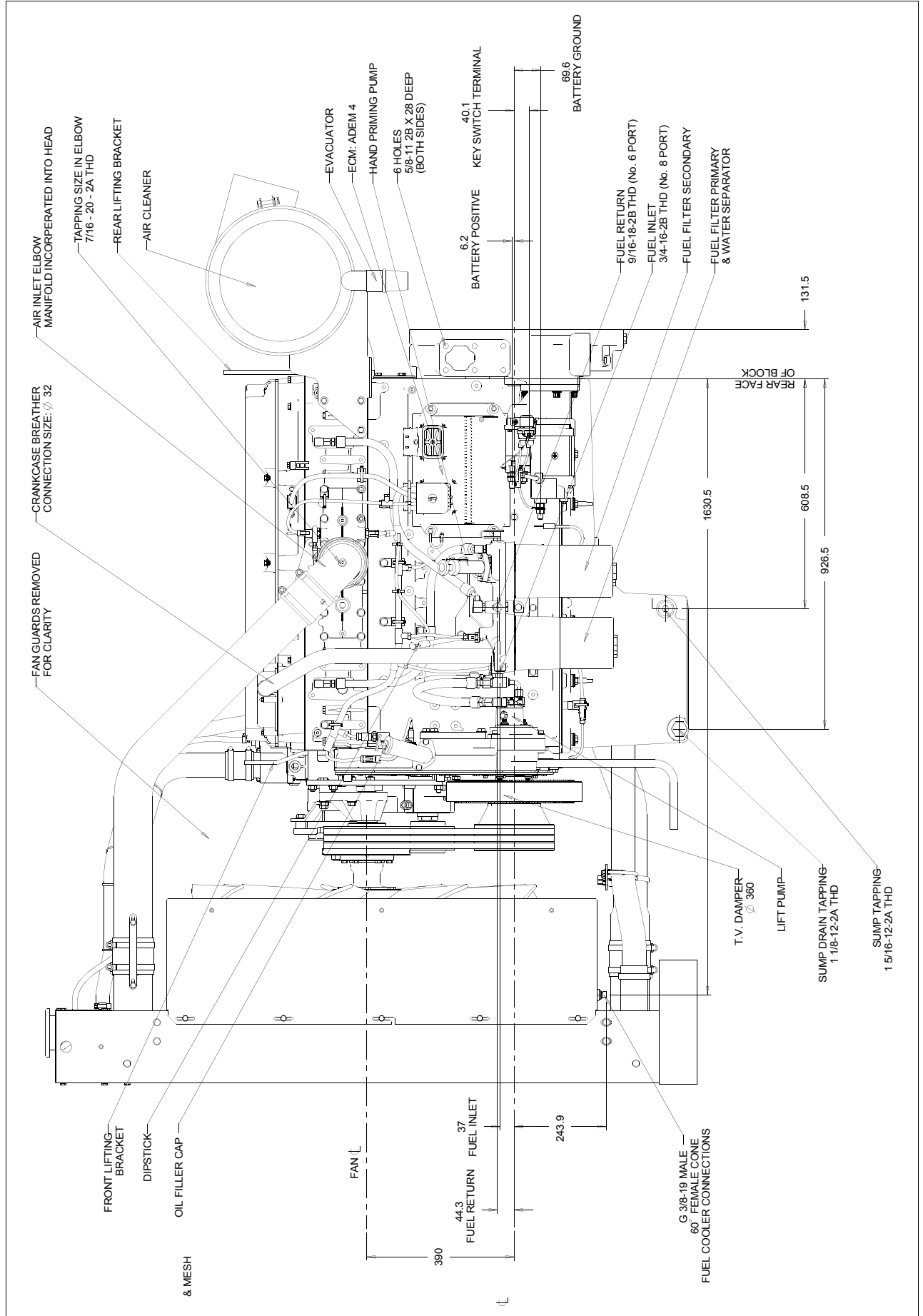

2206C-E13TAG2 and 2206C-E13TAG3 - GA Z13622 (50Hz)

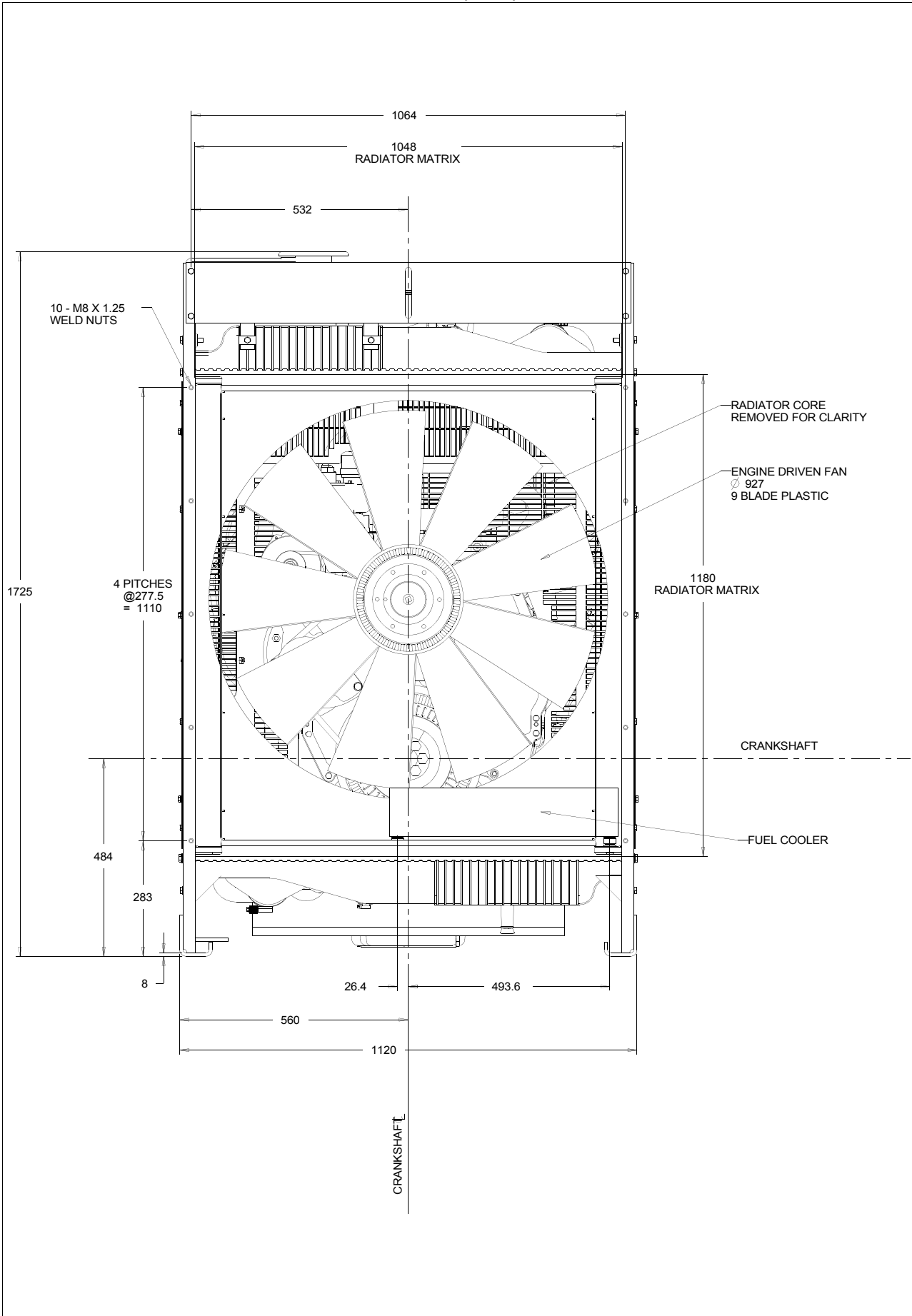

2206C-E13TAG2 and 2206C-E13TAG3 - GA Z13622 (50Hz)

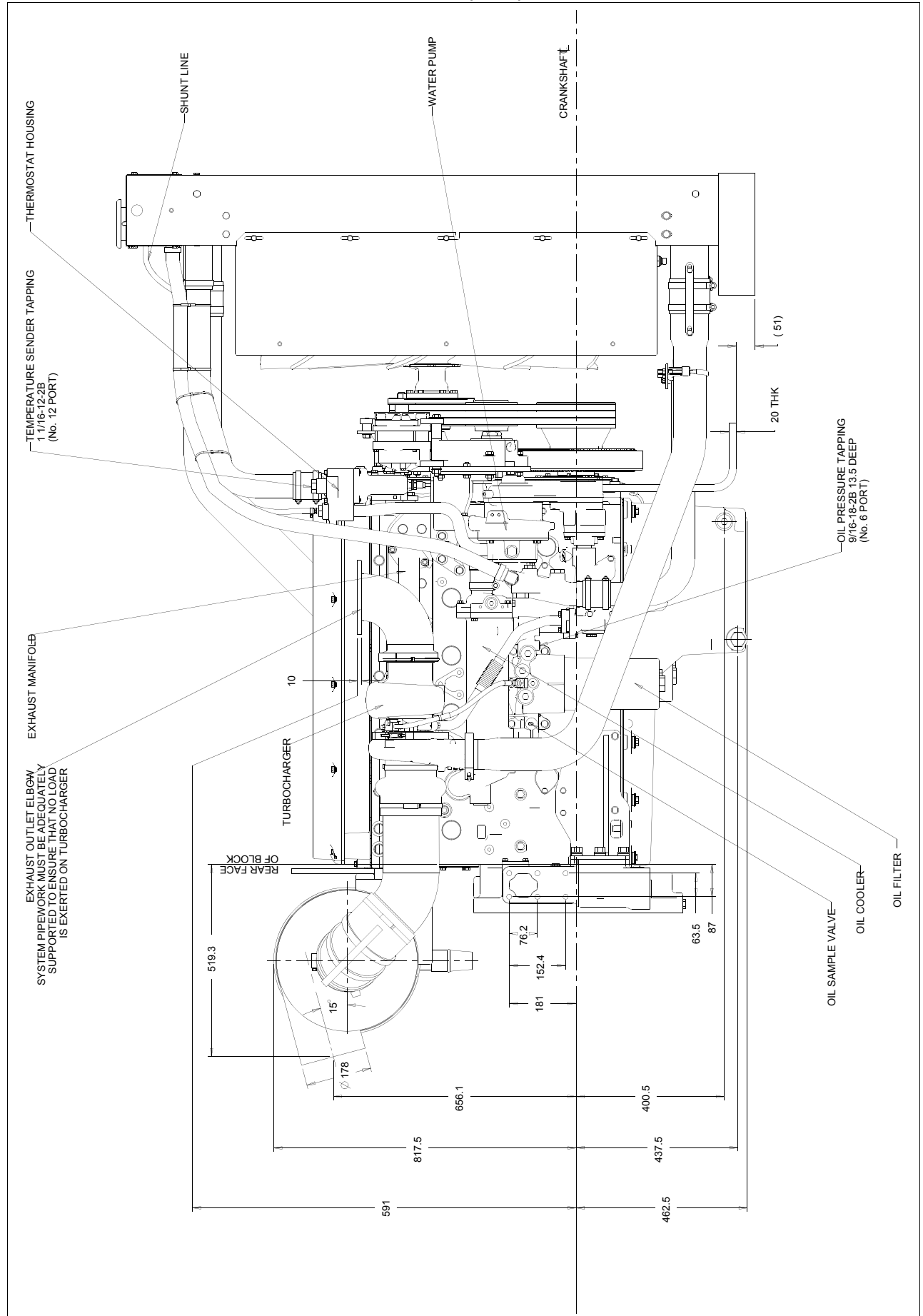

2206C-E13TAG2 and 2206C-E13TAG3 - GA Z13622 (50Hz)

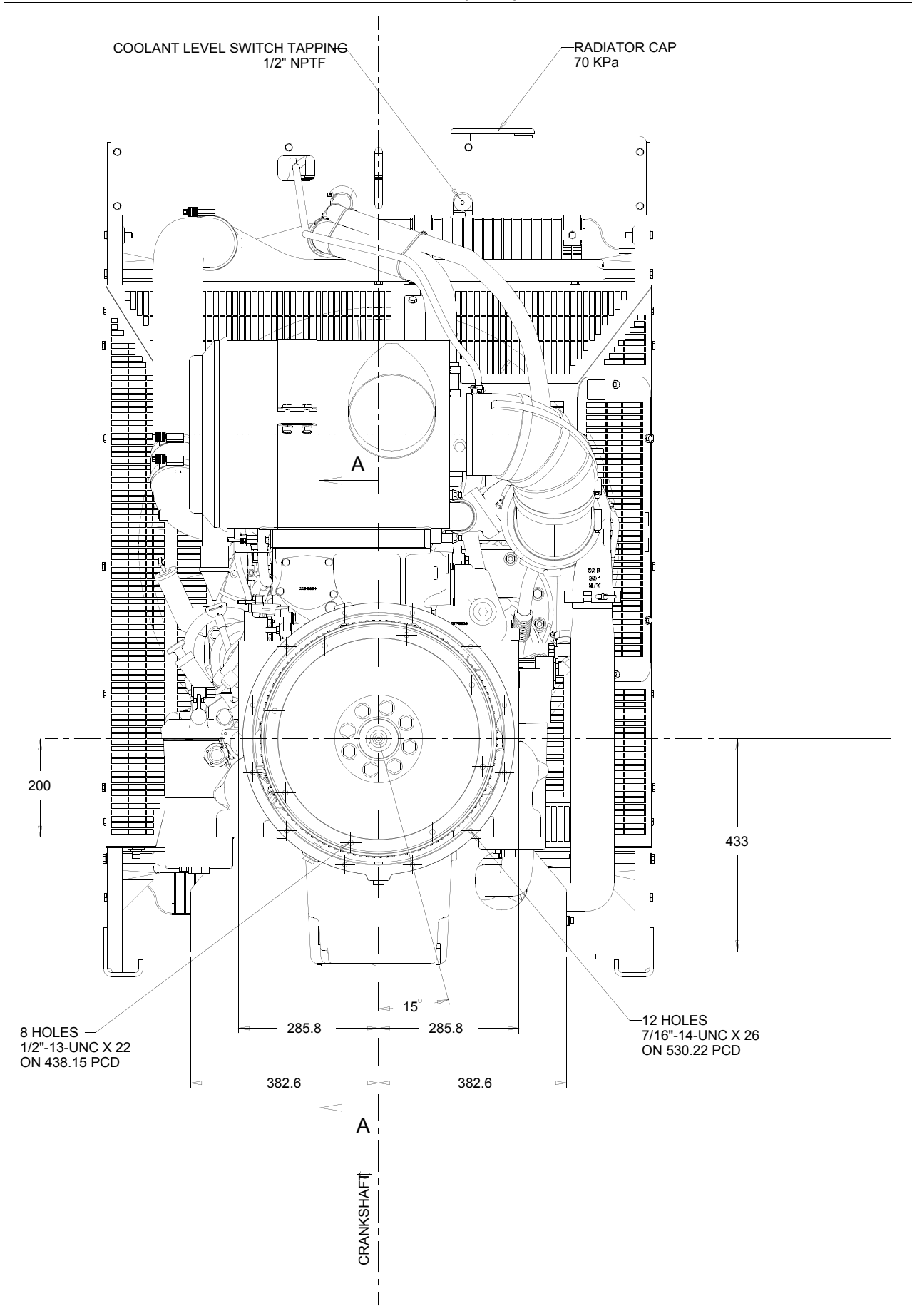

2206C-E13TAG2 and 2206C-E13TAG3 - GA Z13622 (50Hz)

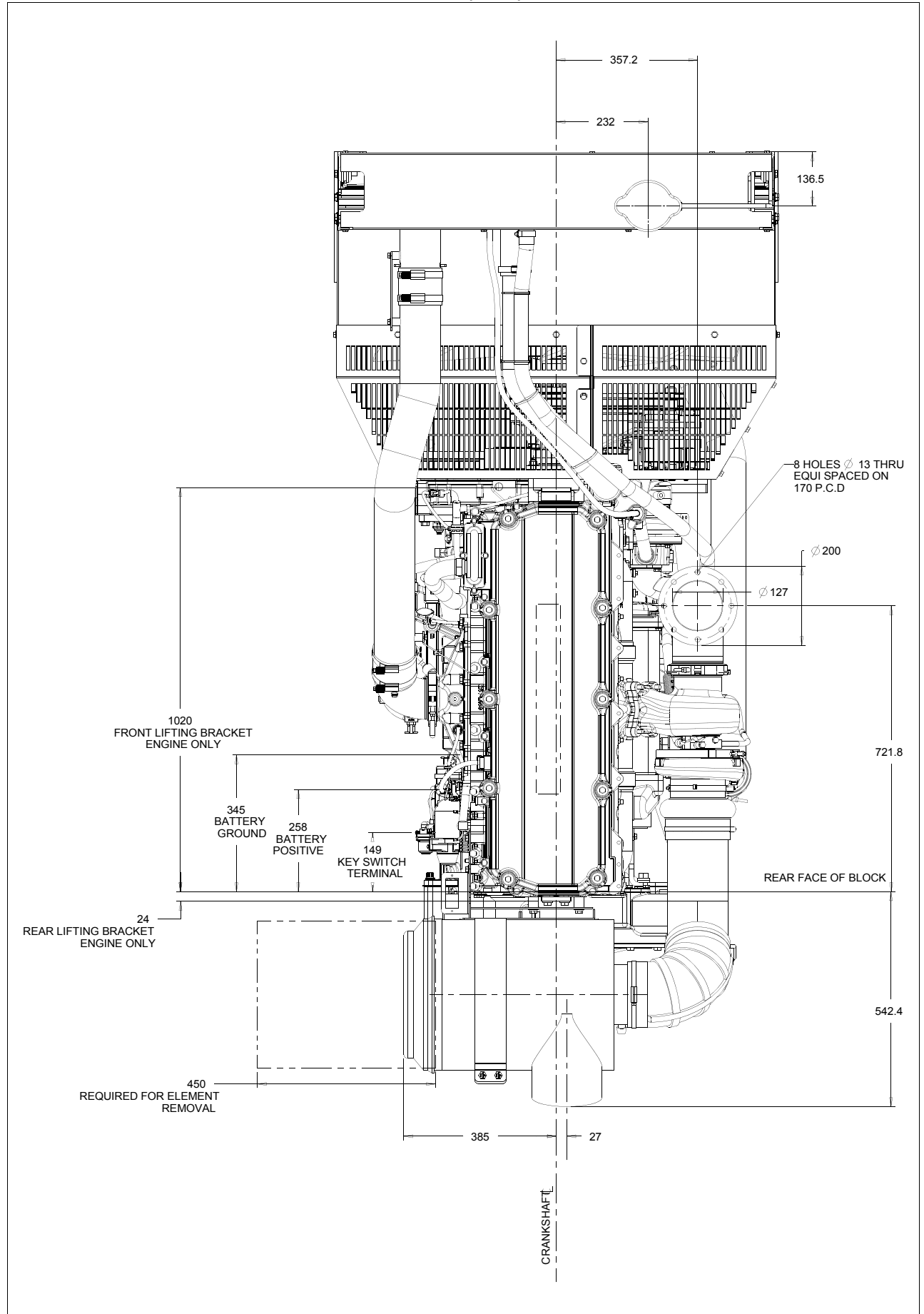

2206C-E13TAG2 and 2206C-E13TAG3 - GA Z13622 (50Hz)

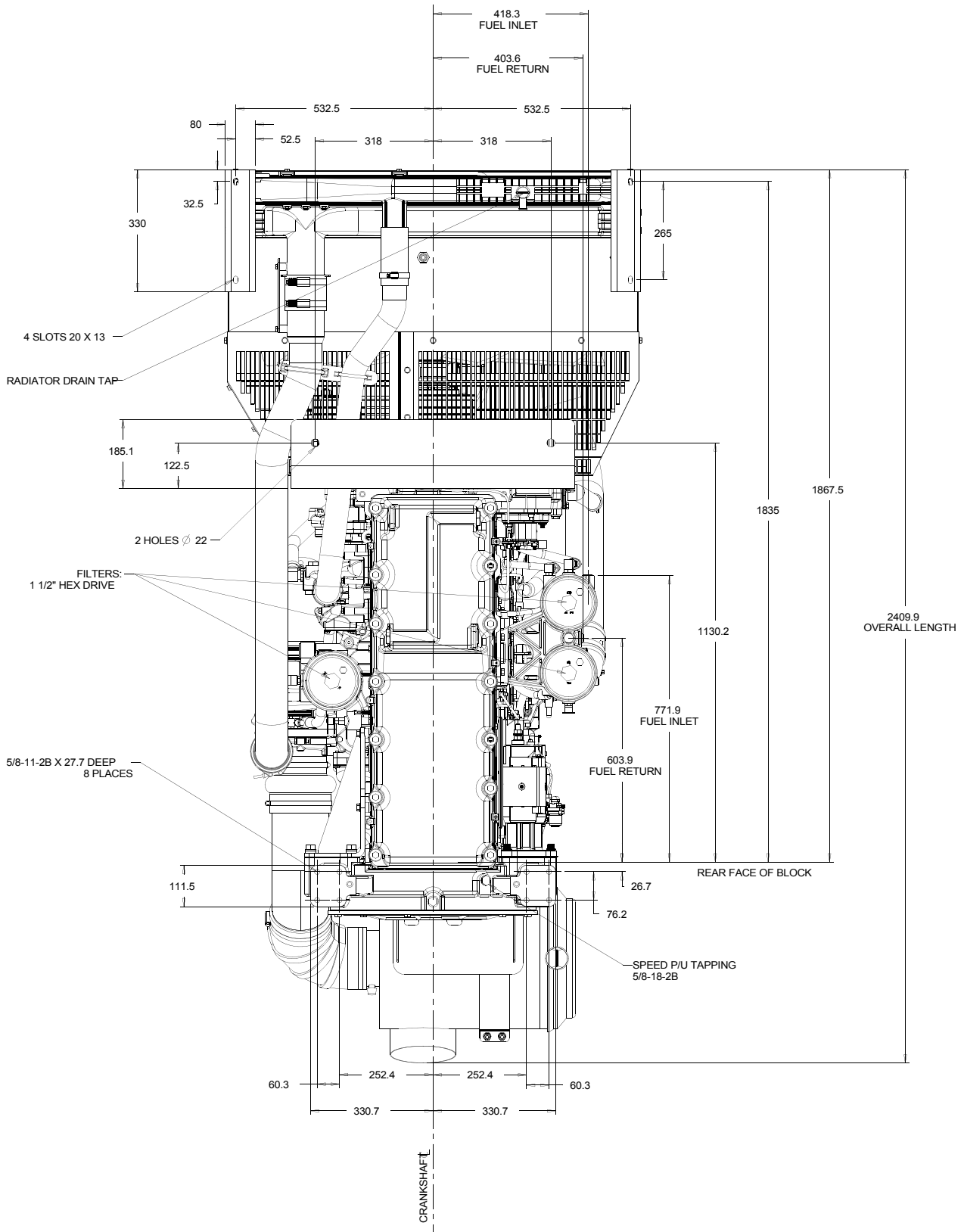

2206C-E13TAG2 and 2206C-E13TAG3 - GA Z13620 (50Hz)

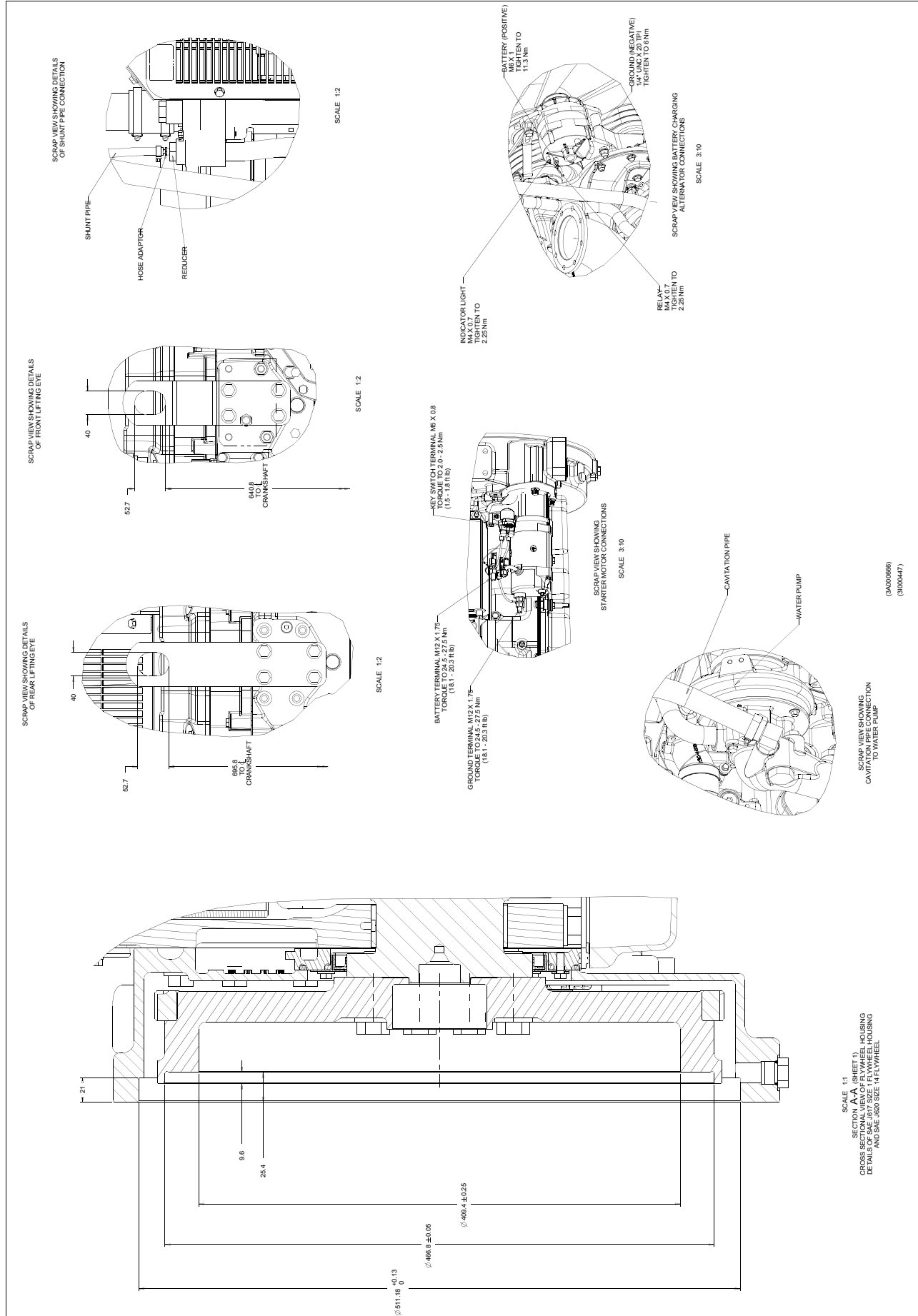

2206C-E13TAG2 and 2206C-E13TAG3 - GA Z13620 (50Hz)

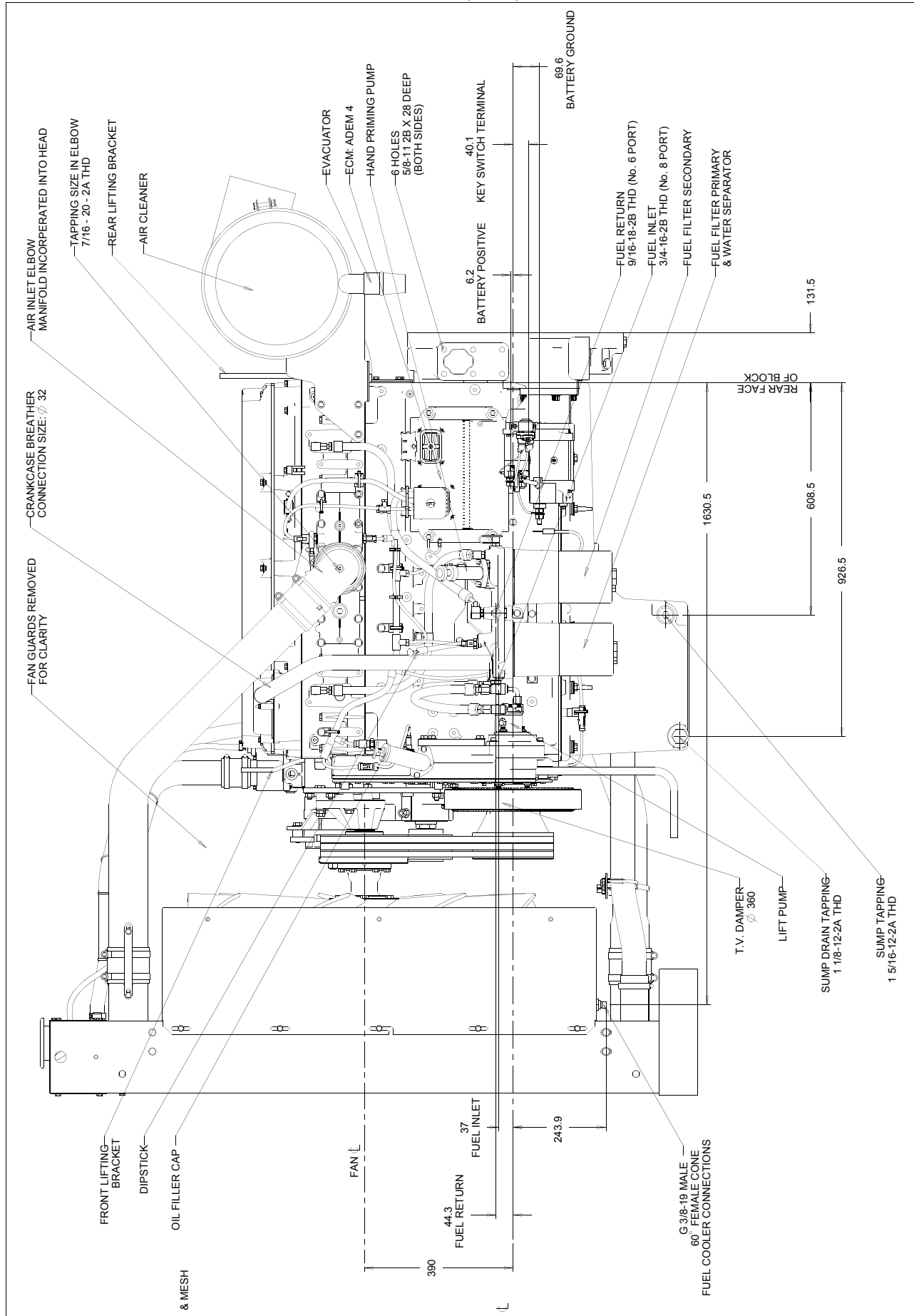

2206C-E13TAG2 and 2206C-E13TAG3 - GA Z13620 (50Hz)

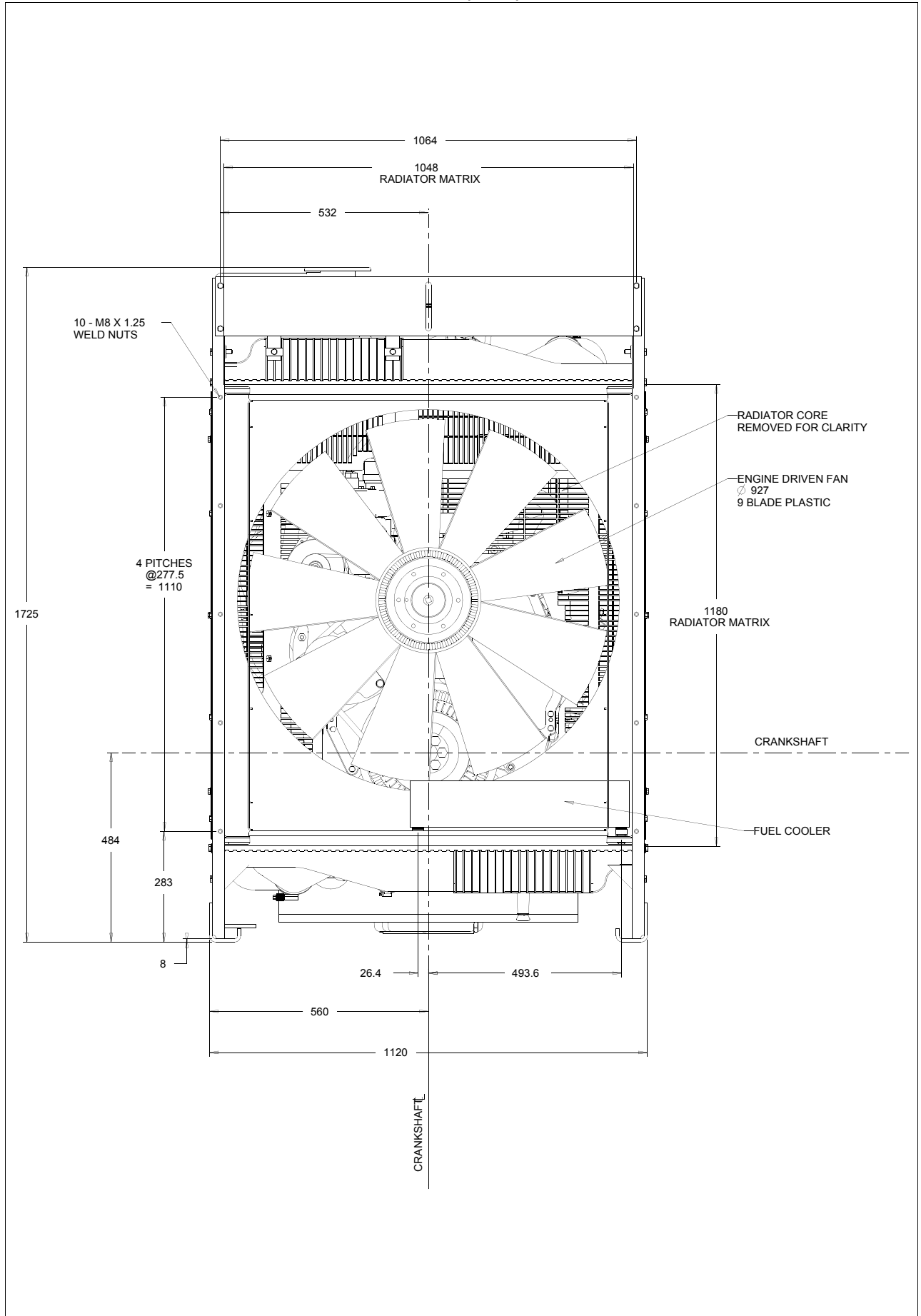

2206C-E13TAG2 and 2206C-E13TAG3 - GA Z13620 (60Hz)

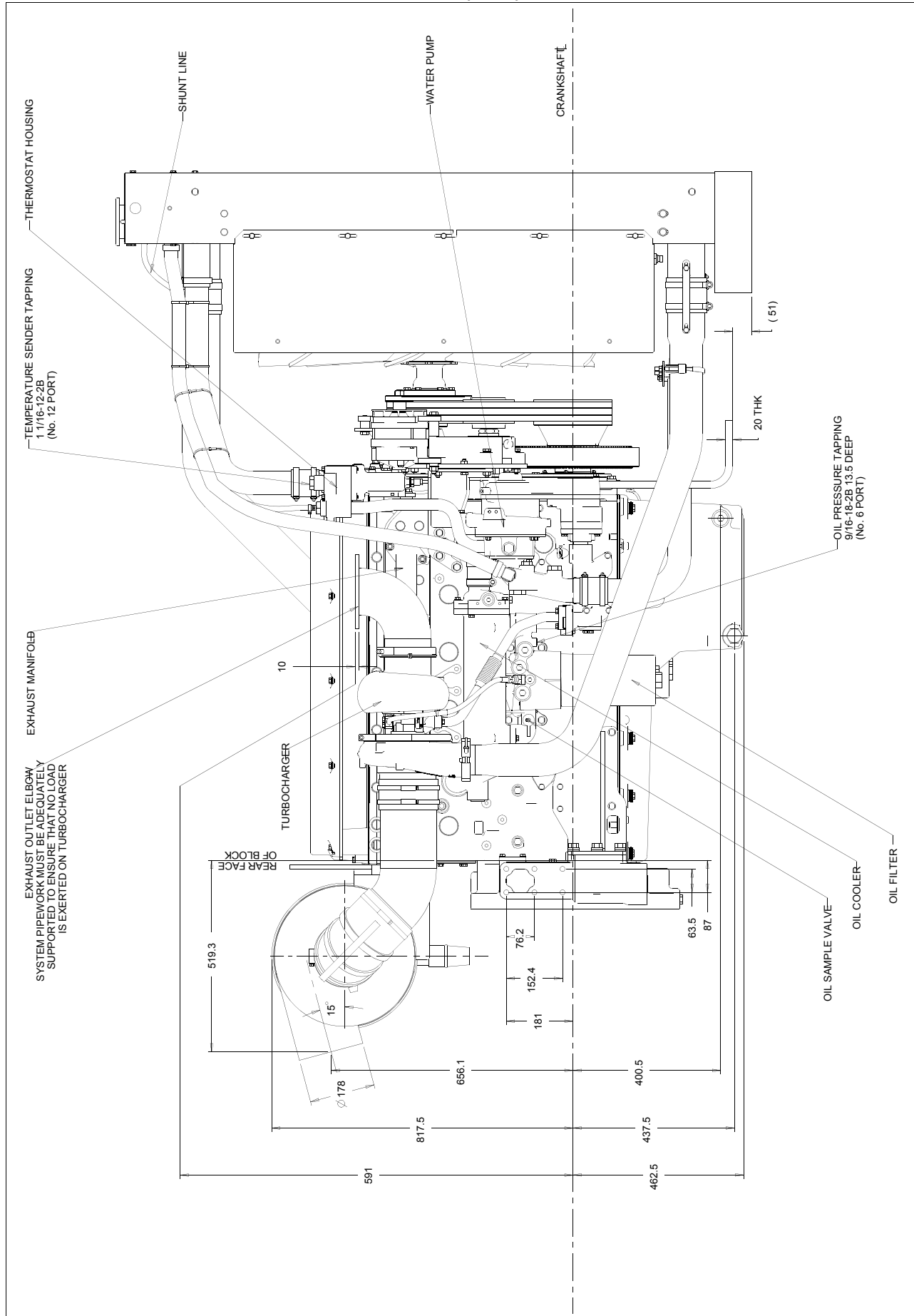

2206C-E13TAG2 and 2206C-E13TAG3 - GA Z13620 (50Hz)

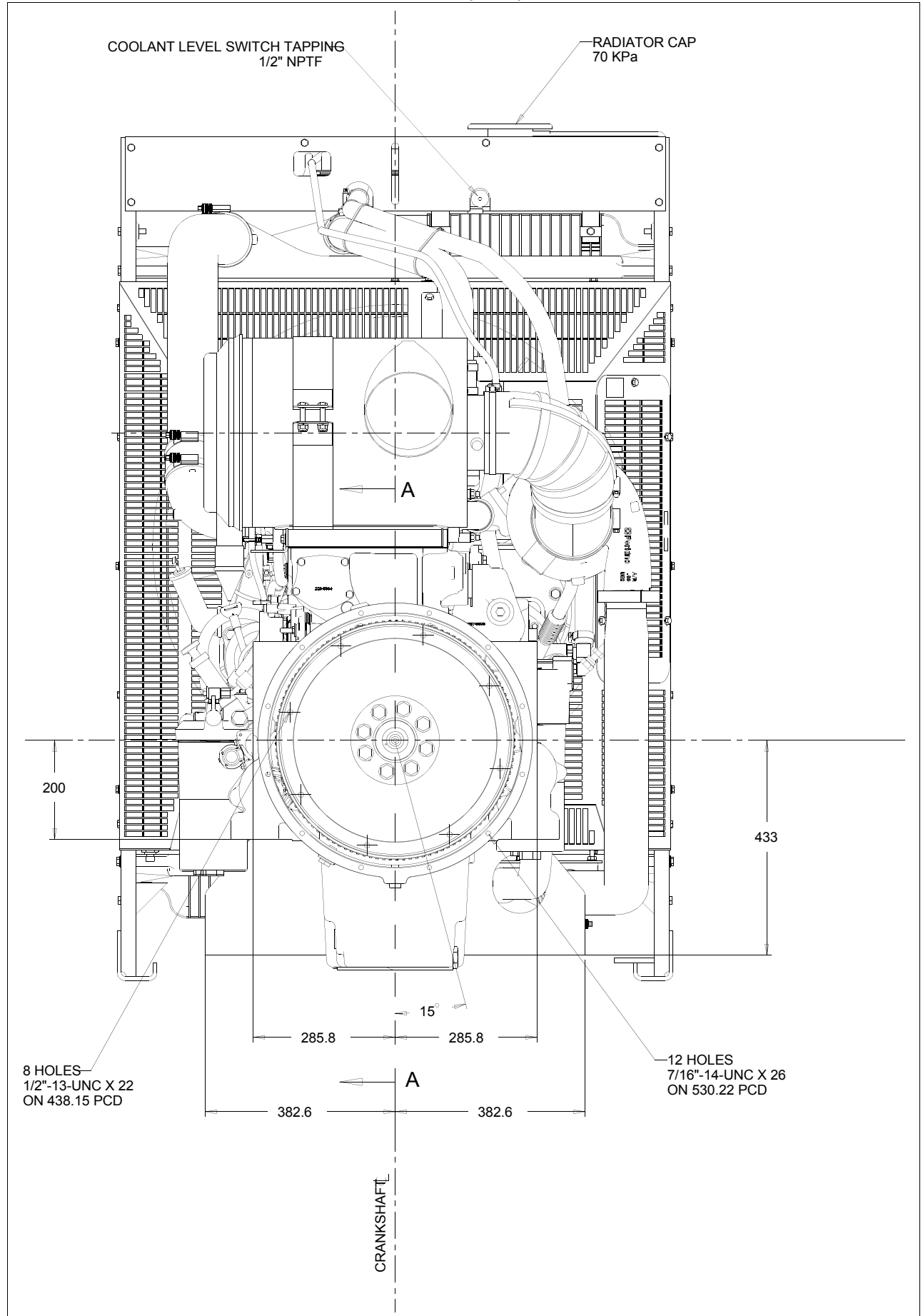

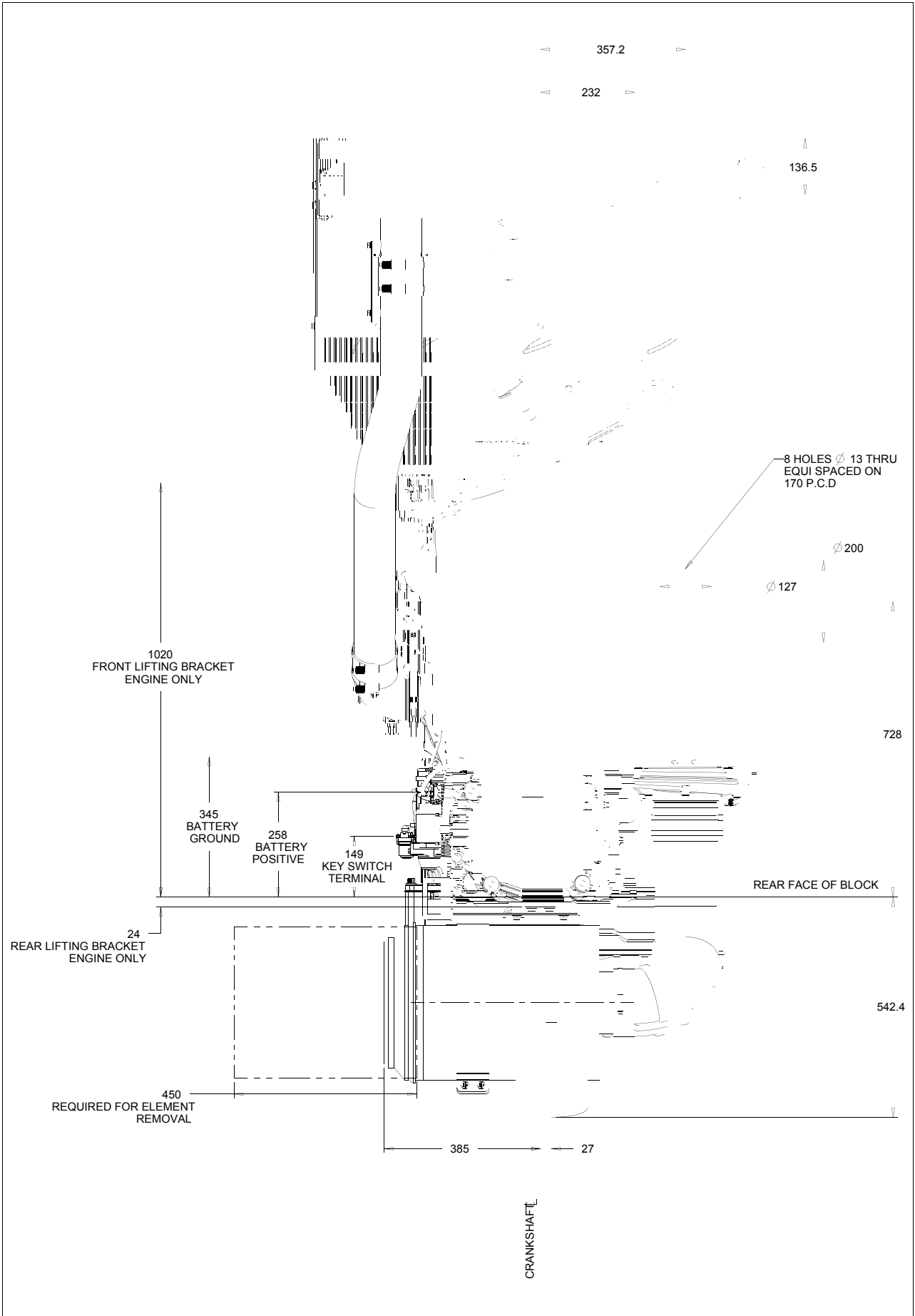

2206C-E13TAG2 and 2206C-E13TAG3 - GA Z13620 (50Hz)

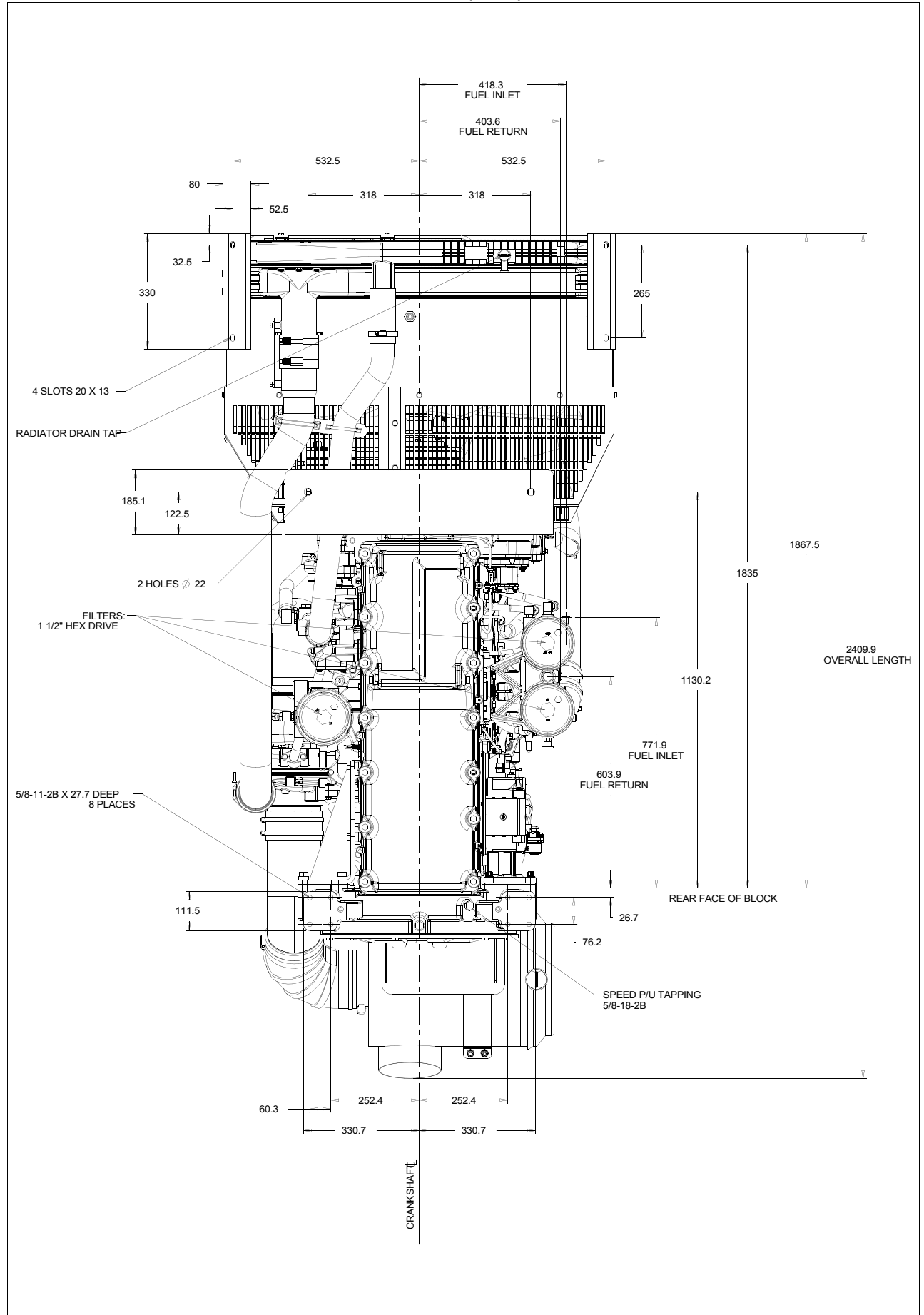

2206C-E13TAG2 and 2206C-E13TAG3 - GA Z13620 (50Hz)

SCRAP VIEW SHOWING DETAILS OF REAR LIFTING EYE

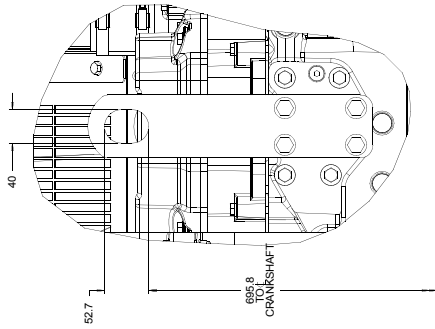

SCALE 1:2

SCRAP VIEW SHOWING DETAILS OF FRONT LIFTING EYE

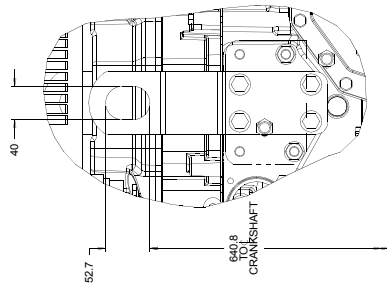

SCALE 1:2

SCRAP VIEW SHOWING DETAILS OF SHUNT PIPE CONNECTION

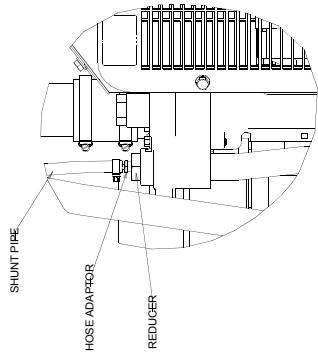

SCALE 1:2

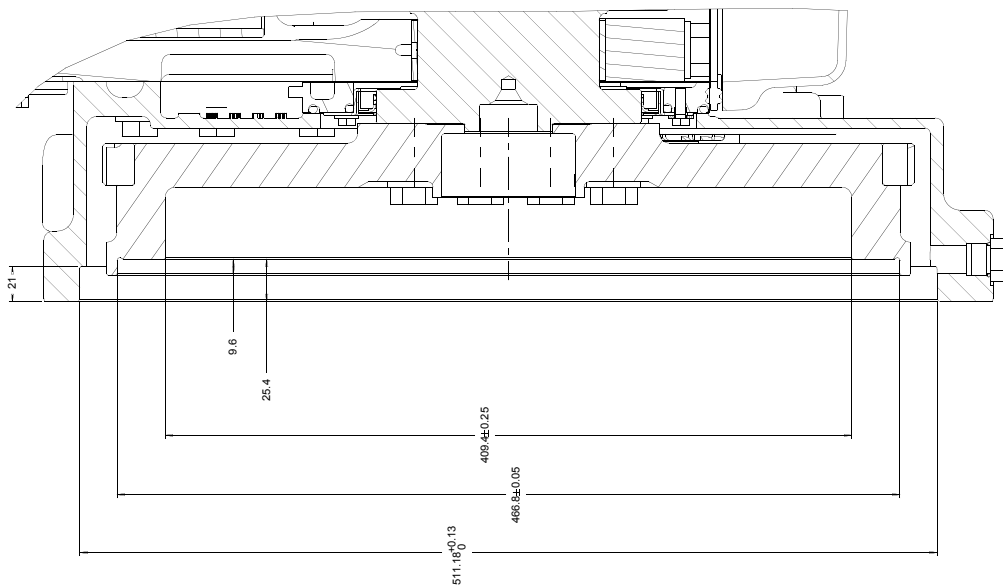

SCALE 1:1
SECTIONAL SHEET 1)
CROSS SECTIONAL VIEW OF FLYWHEEL HOUSING
DETAILS OF SAE J817 SIZE 1 FLYWHEEL HOUSING
AND SAE J860 SIZE 14 FLYWHEEL

KEY SWITCH TERMINAL M5 X 0.8
TORQUE TO 2.0 - 2.5 Nm
(1.5 - 1.8 ft lb)

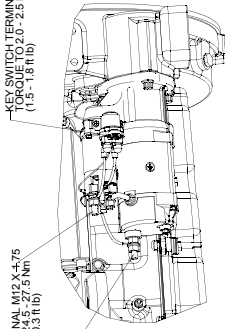

SCRAP VIEW SHOWING
STARTER MOTOR CONNECTIONS
SCALE 3:10

BATTERY TERMINAL M12 X 4-75
TORQUE TO 7.5 Nm
(18.1 - 20.3 ft lb)

GROUND TERMINAL M12 X 4-75
TORQUE TO 7.5 Nm
(18.1 - 20.3 ft lb)

INDICATOR LIGHT
M4 X 0.7
TORQUE TO
2.25 Nm

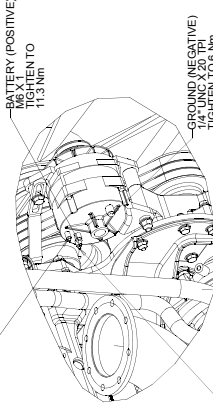

BATTERY (POSITIVE)
TORQUE TO
11.3 Nm

GROUND (NEGATIVE)
1/4 UNC X 20 TPI
TORQUE TO 6 Nm

RELAY
TORQUE TO
2.25 Nm

SCALE 3:10

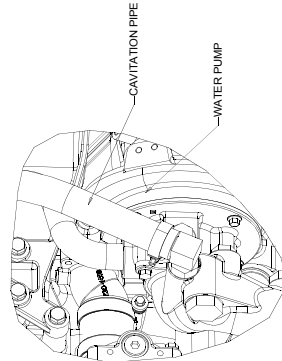

SCRAP VIEW SHOWING
CAVITATION PIPE CONNECTION
TO WATER PUMP

(39600688b)
(39600447)

Cooling system

Radiator

Face area	1,238 m ²
Number of rows and materials	1rows, aluminium
Matrix density and material	12 fins per inch, aluminium
Width of matrix	1048 mm
Height of matrix	1100 mm
Weight of radiator (dry)	132 kg
Pressure cap setting (min)	70 kPa

Charge cooler

Face area	1,006 m ²
Number of rows and materials	1rows, aluminium
Matrix density and material	12 fins per inch, aluminium
Width of matrix	915 mm
Height of matrix	1100 mm

Coolant pump

Speed @ 1500 rev/min	2056 rev/min
Speed @ 1800 rev/min	2468 rev/min
Drive method	Gear

Fan

Diameter	927 mm
Drive ratio	0,92:1
Number of blades	9
Material	composite
Type	pusher
Cooling fan air flow @ 1500 rev/min	654 m ³ /min
Cooling fan air flow @ 1800 rev/min	788 m ³ /min

Coolant

Total system capacity	51,4 litres
Max. top tank temperature	104 °C
Temperature rise across engine	10 °C
Max. pressure in engine cooling circuit	70 kPa
Max. permissible external system resistance	30 kPa
Max. static pressure head on pump	30 kPa
Coolant flow against 30 kPa restriction	
-1500 rev/min	5,3 litres/sec
-1800 rev/min	6,7 litres/sec
Thermostat operation range	87 to 98°C

For details of recommended coolant specifications, refer to the Operation and Maintenance Manual for this engine model

Duct allowance

Duct allowance 2206C-E13TAG2			
Maximum additional restriction (duct allowance) to cooling airflow and resultant minimum airflow			
Engine speed rev/min	Ambient clearance inhibited coolant °C	Duct allowance Pa	m ³ /min
1500	59	200	563
1800	59	200	716

Duct allowance 2206C-E13TAG3			
Maximum additional restriction (duct allowance) to cooling airflow and resultant minimum airflow			
Engine speed rev/min	Ambient clearance inhibited coolant °C	Duct allowance Pa	m ³ /min
1500	52	200	563
1800	57	200	716

Electrical system

-type	24 Volt negative earth
Alternator type	22SI
-alternator voltage	24V
-alternator output	70A
Starter motor type	39MT
-starter motor voltage	24V
-starter motor power	7,8 kW
Number of teeth on flywheel	113
Number of teeth on starter pinion	11
Minimum cranking speed	106 rev/min
Starter solenoid maximum	
-pull-in current @ -25°C	200A
-hold-in current @ -25°C	25A

Cold start recommendations

-5°C to -10°C

Oil	SAE grade 15W40
Starter	42MT
Battery	24V
Max. breakaway current	1311A
Cranking current	588A
Starting aids (ECM controlled)	none
Min. mean cranking speed	106 rev/min

-11°C to -25°C

Oil	SAE grade 5W40
Starter	42MT
Battery	24 volts
Max. breakaway current	1585 amps
Cranking current	828 amps
Starting aids (ECM controlled)	block heater 1,5 (110V/240V)
Min. mean cranking speed	106 rev/min

Notes:

- Battery capacity is defined by the 20 hour rate
- The oil specification should be for the minimum ambient temperature as the oil will not be warmed by the immersion heater
- Breakaway current is dependent on the battery capacity available. Cables should be capable of handling transient current twice that of cranking current.

Exhaust system

Maximum back pressure

-1500 rev/min	10,0 kPa
-1800 rev/min	10,0 kPa
Exhaust outlet, internal diameter	123 mm

Fuel system

Injection system	MEUI
Injector type	MEUI
Governor type	electronic
Governing conforms to	ISO8528-5 Class G2
Injector pressure	207 MPa

Fuel lift pump

-lift pump type	gear driven
-lift pump delivery - 1500 rev/min	480 litres/min
-lift pump delivery - 100 rev/min	600 litres/min
-lift pump delivery pressure	621 kPa
-max. suction head at pump inlet	3 m
-max. static pressure head	4 m
-max. fuel inlet temperature	55 °C
-fuel filter spacing primary	10 microns
-fuel filter spacing secondary	2 microns

Fuel specification

BS2869 Class A2 or BSEN590
ASTM D975 Class 1D and class 2D

Note: For further information on fuel specifications and restrictions, refer to the OMM, "Fluid Recommendations" for this engine model.

Induction system

Maximum air intake restriction

-clean filter	2,5 kPa
-dirty filter	6,4 kPa
-air filter type	paper element - 15 inch diameter

Lubrication system

Maximum total system oil capacity ... 40 litres
 Minimum oil capacity in sump ... 32,5 litres
 Maximum oil capacity in sump ... 38 litres
 Maximum engine operating angles -
 front up, front down, right side, left side ... 7°

Lubricating oil

-oil flow @ 1500 rev/min ... 140 litres/min
 -oil flow @ 1800 rev/min ... 172 litres/min
 -oil pressure at bearings (1500 rev/min) ... 310 kPa
 -oil pressure at bearings (1800 rev/min) ... 358 kPa
 -oil pressure at bearings (min) ... 270 kPa
 -oil temperature (continuous operation) ... 113 °C
 -oil consumption at full load as a % of fuel consumption ... 0.15%
 Oil filter screen spacing ... 30 microns
 Oil consumption as % of fuel consumption ... 0,1
 Sump drain plug tapping ... 1 1/8 UNF
 Lubricating oil specification ... API-CH4 - SAE15W-40

Recommended SAE viscosity

Engine Oil Viscosity		
EMA LRG-1 API CH-4 Viscosity Grade	Ambient Temperature	
	Minimum	Maximum
SAE 0W20	-40 °C	10 °C
SAE 0W30	-40 °C	30 °C
SAE 0W40	-40 °C	40 °C
SAE 5W30	-30 °C	30 °C
SAE 5W40	-30 °C	40 °C
SAE 10W30	-20 °C	40 °C
SAE 15W40	-10 °C	50 °C

Mountings

Maximum static bending moment at rear face of block ... 1356 Nm

Fuel consumption

Note: All fuel consumption figures are based on Nett power

2206C-E13TAG2 - 1500 rev/min

Load	g/kWhr	l/hr
Standby	205	84
110% Prime power	208	82
100% Prime power	209	75
75% of Prime power	213	58
50% of Prime power	221	40

2206C-E13TAG3 - 1500 rev/min

Load	g/kWhr	l/hr
Standby	202	94
205	205	93
100% Prime power	206	85
75% of Prime power	210	65
50% of Prime power	218	46

2206C-E13TAG2 - 1800 rev/min

Load	g/kWhr	l/hr
Standby	200	90
110% Prime power	203	92
100% Prime power	204	84
75% of Prime power	210	65
50% of Prime power	220	46

2206C-E13TAG3 - 1800 rev/min

Load	g/kWhr	l/hr
Standby	200	90
110% Prime power	203	92
100% Prime power	204	84
75% of Prime power	210	65
50% of Prime power	220	46

All fuel consumption figures are based on Nett power

Load acceptance

TAG2 (cold)

Initial load application: When engine reaches rated speed (15 seconds maximum after engine starts to crank)			
Descriptor	Units	50 Hz	60Hz
% of prime power	%	65	70
Load (nett)	kWm	182	224
Transient frequency deviation	%	<10	<10
Frequency recovery	Seconds	5	5

Second load application: When engine reaches rated speed (5 seconds after initial load application)			
Descriptor	Units	50 Hz	60Hz
% of prime power	%	73	83
Load (nett)	kWm	204,4	272
Transient frequency deviation	%	<10	<10
Frequency recovery	Seconds	5	5

TAG3 (cold)

Initial load application: When engine reaches rated speed (15 seconds maximum after engine starts to crank)			
Descriptor	Units	50 Hz	60Hz
% of prime power	%	57	70
Load (nett)	kWm	182,4	224
Transient frequency deviation	%	<10	<10
Frequency recovery	Seconds	5	5

Second load application: When engine reaches rated speed (5 seconds after initial load application)			
Descriptor	Units	50 Hz	60Hz
% of prime power	%	65	85
Load (nett)	kWm	208	272
Transient frequency deviation	%	<10	<10
Frequency recovery	Seconds	5	5

The information shown above complies with the requirements of classification 3 and 4 of ISO 8528-12 and G2 operating limits stated in ISO 8528-5

The above figures were obtained under the following test conditions:

- minimum engine block temperature..... 45 °C
- ambient temperature..... 15 °C
- governing mode isochronous
- alternator efficiency..... 92%
- alternator inertia 6,9 kgm²
- under frequency roll off (UFRO) point set to..... 1 Hz below rated
- UFRO rate set to..... 2% voltage / 1% frequency
- LAM on/off..... off

All tests were conducted using an engine which was installed and serviced to Perkins Engines Company Limited recommendations.

Note: The general arrangement drawings shown in this data sheet are for guidance only. For installation purposes, latest versions should be requested from the Applications Department, Perkins Engines Stafford, ST16 3UB United Kingdom.



Perkins Engines Company Limited
Peterborough PE1 5NA United Kingdom
Telephone +44 (0) 1733 583000
Fax +44 (0) 1733 582240
www.perkins.com

Distributed by