

# STAMFORD®

## UCDI274K - Technical Data Sheet

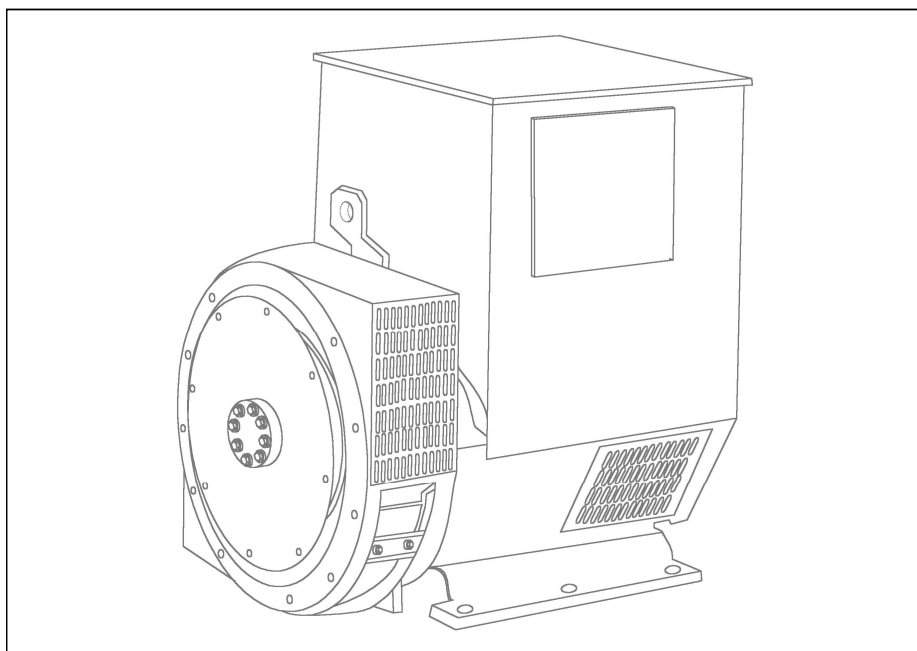

# UCDI274K

## SPECIFICATIONS & OPTIONS

**STAMFORD**

### STANDARDS

Stamford industrial generators meet the requirements of BS EN 60034 and the relevant section of other international standards such as BS5000, VDE 0530, NEMA MG1-32, IEC34, CSA C22.2-100, AS1359.  
Other standards and certifications can be considered on request.

### VOLTAGE REGULATORS

#### SX460 AVR - OBSOLETE

With this self excited control system the main stator supplies power via the Automatic Voltage Regulator (AVR) to the exciter stator. The high efficiency semiconductors of the AVR ensure positive build-up from initial low levels of residual voltage. The exciter rotor output is fed to the main rotor through a three phase full wave bridge rectifier. This rectifier is protected by a surge suppressor against surges caused, for example, by short circuit.

#### AS440 AVR - STANDARD

With this self-excited system the main stator provides power via the AVR to the exciter stator. The high efficiency semiconductors of the AVR ensure positive build-up from initial low levels of residual voltage. The exciter rotor output is fed to the main rotor through a three-phase full-wave bridge rectifier. The rectifier is protected by a surge suppressor against surges caused, for example, by short circuit or out-of-phase paralleling. The AS440 will support a range of electronic accessories, including a 'droop' Current Transformer (CT) to permit parallel operation with other ac generators.

#### MX341 AVR

This sophisticated AVR is incorporated into the Stamford Permanent Magnet Generator (PMG) control system. The PMG provides power via the AVR to the main exciter, giving a source of constant excitation power independent of generator output. The main exciter output is then fed to the main rotor, through a full wave bridge, protected by a surge suppressor. The AVR has in-built protection against sustained over-excitation, caused by internal or external faults. This de-excites the machine after a minimum of 5 seconds. An engine relief load acceptance feature can enable full load to be applied to the generator in a single step. If three-phase sensing is required with the PMG system the MX321 AVR must be used. We recommend three-phase sensing for applications with greatly unbalanced or highly non-linear loads.

#### MX321 AVR

The most sophisticated of all our AVRs combines all the features of the MX341 with, additionally, three-phase rms sensing, for improved regulation and performance. Over voltage protection is built-in and short circuit current level adjustments is an optional facility.

### WINDINGS & ELECTRICAL PERFORMANCE

All generator stators are wound to 2/3 pitch. This eliminates triplen (3rd, 9th, 15th ...) harmonics on the voltage waveform and is found to be the optimum design for trouble-free supply of non-linear loads. The 2/3 pitch design avoids excessive neutral currents sometimes seen with higher winding pitches, when in parallel with the mains. A fully connected damper winding reduces oscillations during paralleling. This winding, with the 2/3 pitch and carefully selected pole and tooth designs, ensures very low waveform distortion.

### TERMINALS & TERMINAL BOX

Standard generators are 3-phase reconnectable with 12 ends brought out to the terminals, which are mounted on a cover at the non-drive end of the generator. A sheet steel terminal box contains the AVR and provides ample space for the customers' wiring and gland arrangements. It has removable panels for easy access.

### SHAFT & KEYS

All generator rotors are dynamically balanced to better than BS6861:Part 1 Grade 2.5 for minimum vibration in operation.

### INSULATION/IMPREGNATION

The insulation system is class 'H'. All wound components are impregnated with materials and processes designed specifically to provide the high build required for static windings and the high mechanical strength required for rotating components.

### QUALITY ASSURANCE

Generators are manufactured using production procedures having a quality assurance level to BS EN ISO 9001.

The stated voltage regulation may not be maintained in the presence of certain radio transmitted signals. Any change in performance will fall within the limits of Criteria 'B' of EN 61000-6-2:2001. At no time will the steady-state voltage regulation exceed 2%.

### DE RATES

All values tabulated on page 8 are subject to the following reductions

5% when air inlet filters are fitted.  
3% for every 500 metres by which the operating altitude exceeds 1000 metres above mean sea level.  
3% for every 5°C by which the operational ambient temperature exceeds 40°C.

Note: Requirement for operating in an ambient exceeding 60°C must be referred to the factory.

*NB Continuous development of our products entitles us to change specification details without notice, therefore they must not be regarded as binding.*

*Front cover drawing typical of product range.*

## WINDING 06

CONTROL SYSTEM	SEPARATELY EXCITED BY P.M.G.		
A.V.R.	MX321	MX341	
VOLTAGE REGULATION	± 0.5 %	± 1.0 %	With 4% ENGINE GOVERNING
SUSTAINED SHORT CIRCUIT	REFER TO SHORT CIRCUIT DECREMENT CURVES (page 7)		
CONTROL SYSTEM	SELF EXCITED		
A.V.R.	SX460	AS440	
VOLTAGE REGULATION	± 1.0 %	± 1.0 %	With 4% ENGINE GOVERNING
SUSTAINED SHORT CIRCUIT	SERIES 4 CONTROL DOES NOT SUSTAIN A SHORT CIRCUIT CURRENT		
INSULATION SYSTEM	CLASS H		
PROTECTION	IP23		
RATED POWER FACTOR	0.8		
STATOR WINDING	SINGLE LAYER CONCENTRIC		
WINDING PITCH	TWO THIRDS		
WINDING LEADS	4		
STATOR WDG. RESISTANCE	0.0048 Ohms PER PHASE AT 22°C SERIES CONNECTED		
ROTOR WDG. RESISTANCE	2.08 Ohms at 22°C		
EXCITER STATOR RESISTANCE	20 Ohms at 22°C		
EXCITER ROTOR RESISTANCE	0.097 Ohms PER PHASE AT 22°C		
R.F.I. SUPPRESSION	BS EN 61000-6-2 & BS EN 61000-6-4, VDE 0875G, VDE 0875N. refer to factory for others		
WAVEFORM DISTORTION	NO LOAD < 1.5% NON-DISTORTING BALANCED LINEAR LOAD < 5.0%		
MAXIMUM OVERSPEED	2250 Rev/Min		
BEARING NON-DRIVE END	BALL. 6310-2RS (ISO)		
WEIGHT COMP. GENERATOR	727 kg		
WEIGHT WOUND STATOR	304 kg		
WEIGHT WOUND ROTOR	272.6 kg		
WR <sup>2</sup> INERTIA	2.3934 kgm <sup>2</sup>		
SHIPPING WEIGHTS in a crate	740 kg		
PACKING CRATE SIZE	123 x 67 x 103 (cm)		
TELEPHONE INTERFERENCE	TIF<50		
COOLING AIR	0.69 m <sup>3</sup> /sec 1463 cfm		
VOLTAGE SERIES	220	230	240
VOLTAGE PARALLEL	110	115	120
kVA BASE RATING FOR REACTANCE VALUES	200	200	200
X <sub>d</sub> DIR. AXIS SYNCHRONOUS	2.18	1.99	1.83
X' <sub>d</sub> DIR. AXIS TRANSIENT	0.13	0.12	0.11
X'' <sub>d</sub> DIR. AXIS SUBTRANSIENT	0.08	0.07	0.07
X <sub>q</sub> QUAD. AXIS REACTANCE	0.99	0.91	0.83
X'' <sub>q</sub> QUAD. AXIS SUBTRANSIENT	0.12	0.11	0.10
X <sub>L</sub> LEAKAGE REACTANCE	0.07	0.06	0.06
X <sub>2</sub> NEGATIVE SEQUENCE	0.09	0.08	0.08
X <sub>0</sub> ZERO SEQUENCE	0.04	0.04	0.03
REACTANCES ARE SATURATED	VALUES ARE PER UNIT AT RATING AND VOLTAGE INDICATED		
T' <sub>d</sub> TRANSIENT TIME CONST.	0.049 s		
T'' <sub>d</sub> SUB-TRANSTIME CONST.	0.02 s		
T' <sub>do</sub> O.C. FIELD TIME CONST.	1.27 s		
T <sub>a</sub> ARMATURE TIME CONST.	0.018 s		
SHORT CIRCUIT RATIO	1/X <sub>d</sub>		

**60  
Hz**

**UCDI274K**  
Winding 06

**STAMFORD**

**SINGLE PHASE EFFICIENCY CURVES**

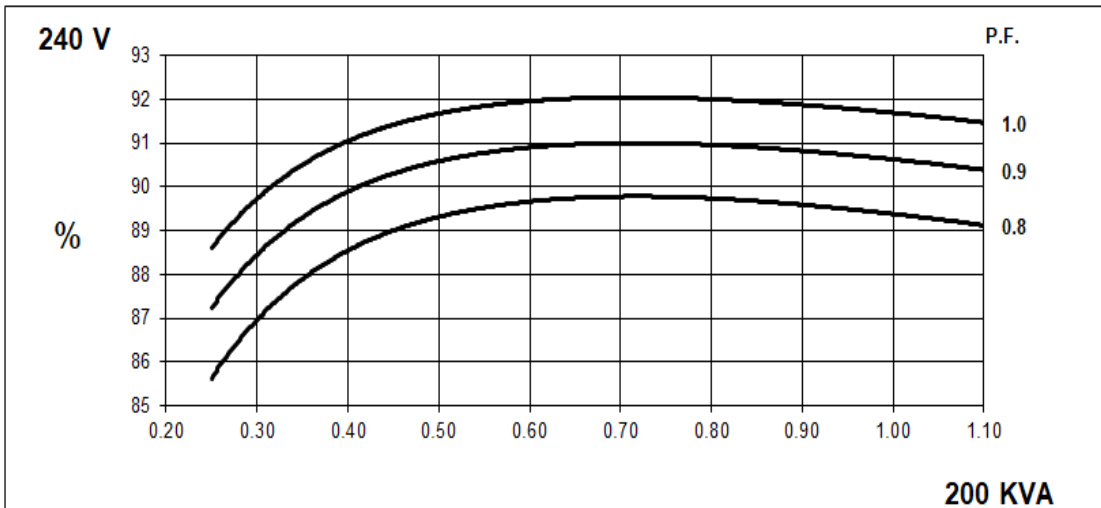
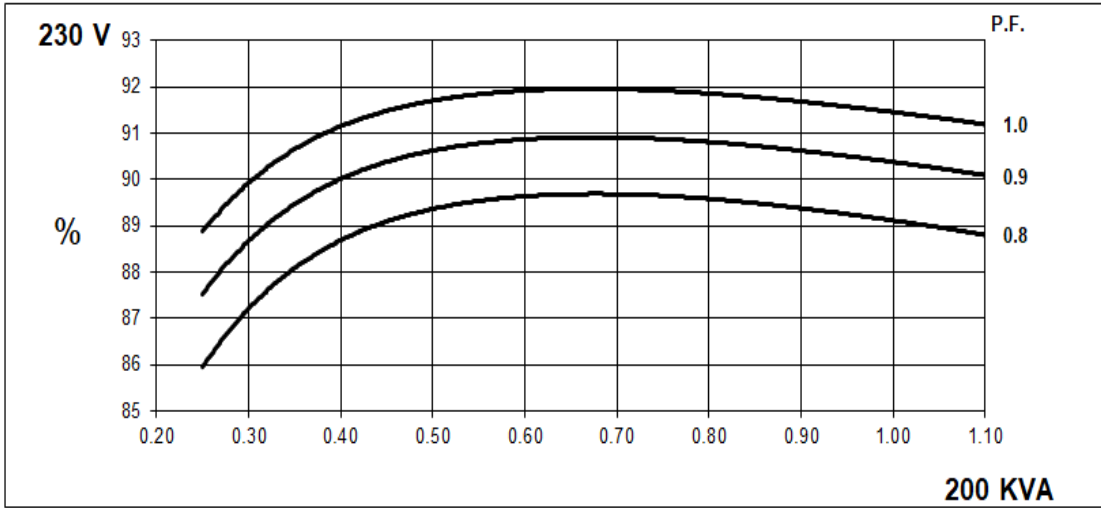
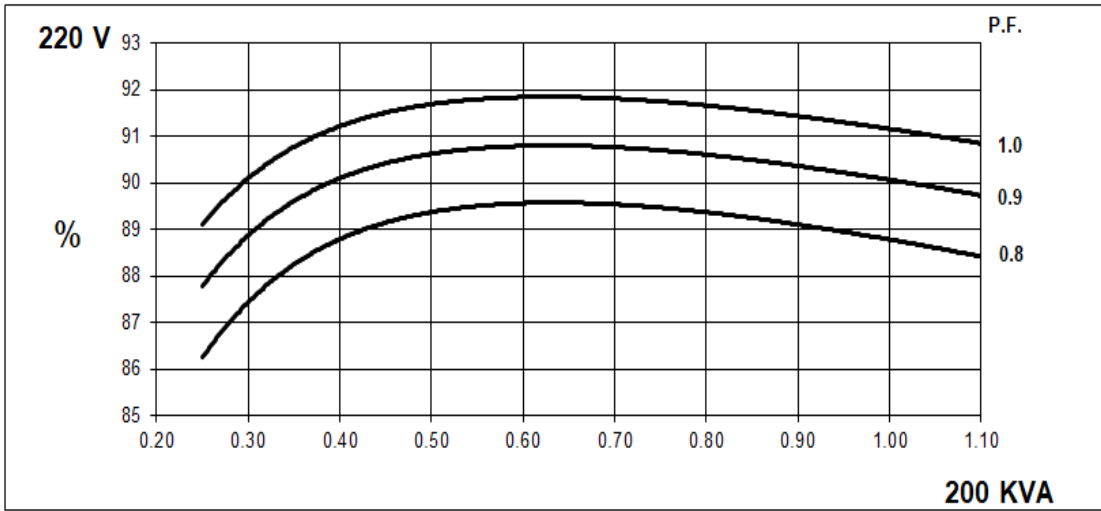

Locked Rotor Motor Starting Curves

**SX**

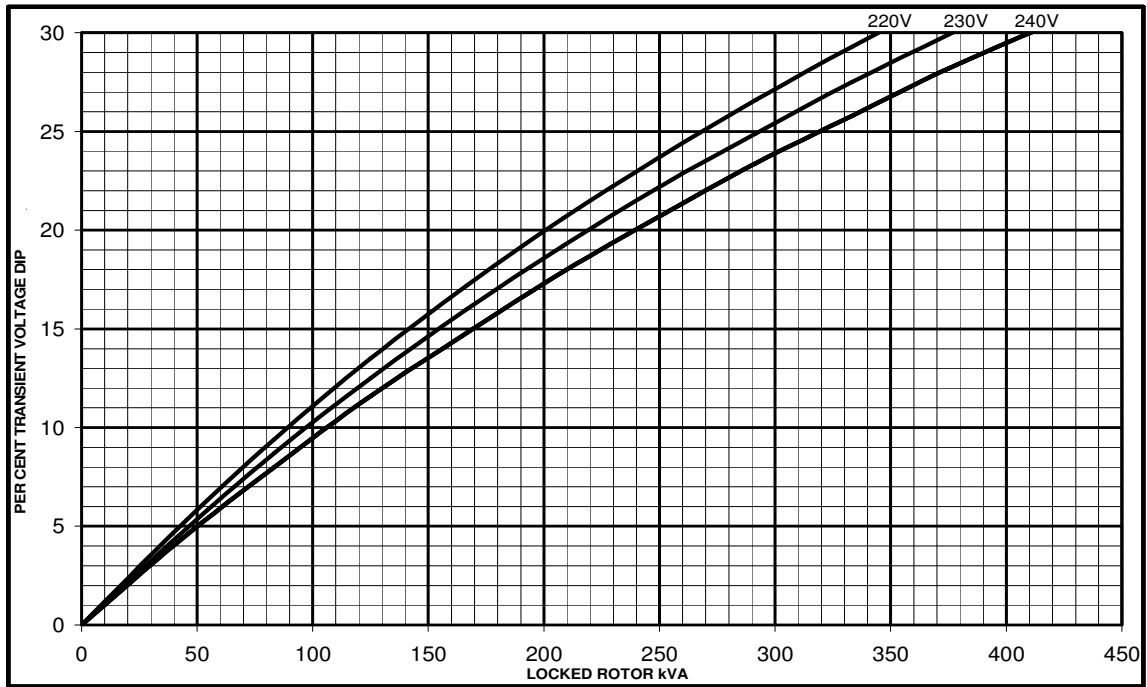

**MX**

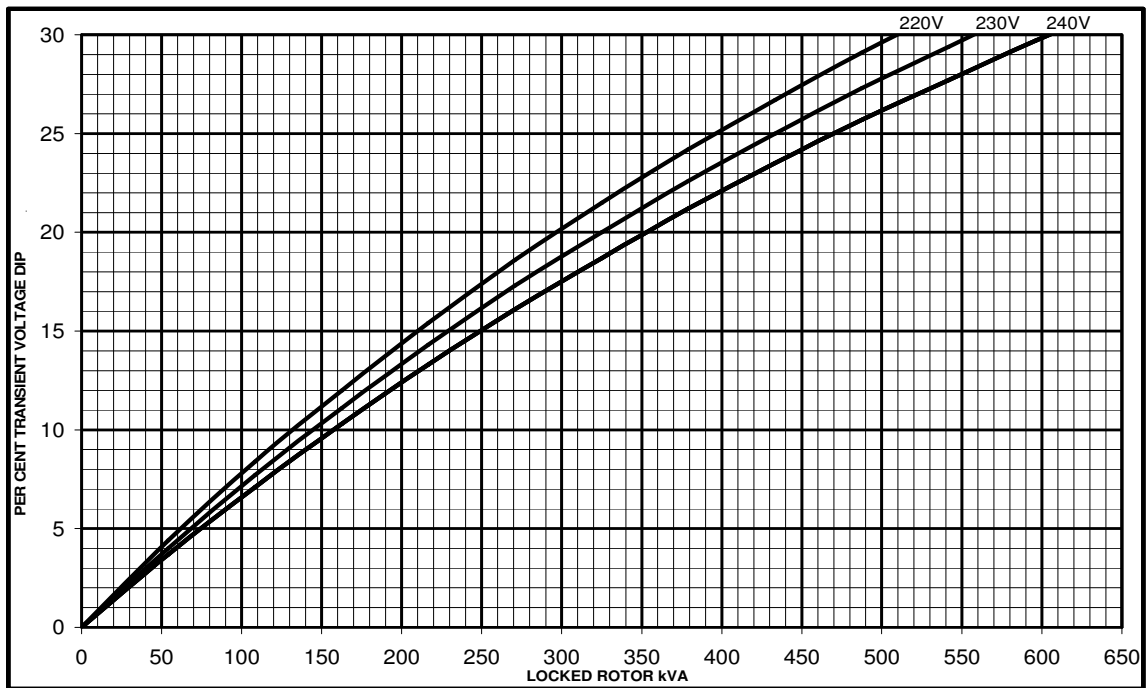

**UCDI274K**  
Winding 06

**STAMFORD**

**Short Circuit Decrement Curve. No-load Excitation at Rated Speed  
Based on series connection.**

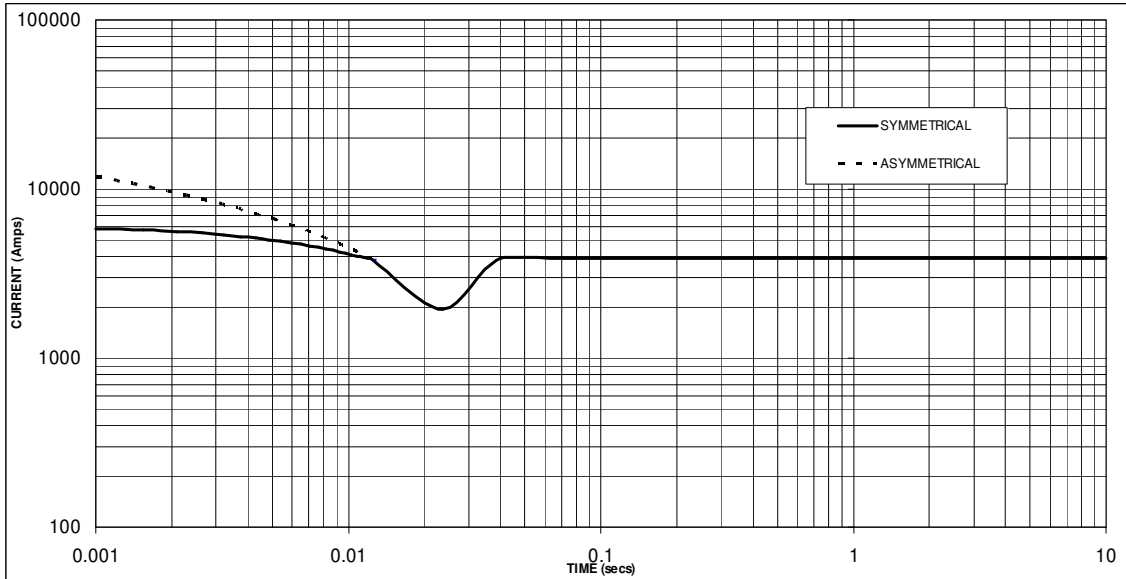

Sustained Short Circuit = 3900 Amps

**Note**

The following multiplication factors should be used to adjust the values from curve between time 0.001 seconds and the minimum current point in respect of nominal operating voltage :

Voltage	Factor
220V	X 1.00
230V	X 1.05
240V	X 1.09

The sustained current value is constant irrespective of voltage level

**UCDI274K****STAMFORD**

Winding 06

**60Hz****RATINGS**

Class - Temp Rise	Cont. F - 105/40°C			Cont. H - 125/40°C			Cont. F - 105/40°C			Cont. H - 125/40°C		
	<b>0.8pf</b>			<b>0.8pf</b>			<b>1.0pf</b>			<b>1.0pf</b>		
Series (V)	220	230	240	220	230	240	220	230	240	220	230	240
Parallel (V)	110	115	120	110	115	120	110	115	120	110	115	120
kVA	160	160	160	200	200	200	160	160	160	200	200	200
kW	128	128	128	160	160	160	160	160	160	200	200	200
Efficiency (%)	89.4	89.6	89.8	88.8	89.1	89.4	91.7	91.9	92.0	91.2	91.5	91.7
kW Input	143.2	142.9	142.5	180.2	179.6	179.0	174.5	174.1	173.9	219.3	218.6	218.1

**Dimensional and Torsional Drawing**

For dimensional and torsional information please refer to the alternator General Arrangement and rotor drawings available on our website (<http://stamford-avk.com/>)

**STAMFORD**

© 2022. Cummins Generator Technologies Ltd. All rights reserved.  
 Cummins and the Cummins logo are registered trade marks of Cummins Inc.  
 STAMFORD is a registered trade mark of Cummins Generator Technologies Ltd.